

Operation Manual

MPL-H11FLX



McLAUGHLIN VISION FLX2

DIGITAL LOCATOR

TAKACHIHO SANGYO CO., LTD.

Table of Contents

1. Safety	1
2. Introduction	3
3. Composition	4
3-1. Main equipment & standard accessories	4
3-2. Optional equipment	4
4. Specification	5
5. Description of parts & basic operation	7
5-1. Transmitter	7
5-2. Receiver	9
6. Warning Message	12
7. Operation of Transmitter (TX)	13
7-1. Direct connection mode	14
7-2. External coil mode	17
7-3. Indirect (Inductive) mode	19
8. Operation of Receiver (RX)	21
8-1. Peak & Null mode	22
8-2. Null mode	23
8-3. Peak mode	23
8-4. Depth measurement (High precision)	24
8-5. Logging data	25
8-6. Current index (Current measurement)	26
8-7. Passive mode	28
8-8. Probe for non-metallic pipe	30
9. Precautions and applications (At the locating site)	32

1. SAFETY

Always locate with proper respect and caution. Equipment misuse or carelessness can result in serious injury or damage to property. Always follow safety rules.

HAZARD ALERT INFORMATION

BE AWARE OF SAFETY INFORMATION

This is a safety-alert sign. This is placed in the manual and on your equipment to alert you to the potential for bodily injury or death.



SIGNAL WORDS

The safety-alert icon is used with the following signal word : DANGER, WARNING, AND CAUTION. When you see these words in the manual or on decals on your equipment, carefully read and follow all instructions. Watch for these words and learn their meanings.

DANGER – Imminent hazards which, if not avoided, will result in death or serious injury.



WARNING – Potentially hazardous situation which, if not avoided, could result in death or serious injury.



CAUTION – Potentially hazardous situation which, if not avoided, may result in minor personal injury or property damage.



OPERATOR PREPARATIONS

Important : Read and understand this manual before using the Verifier/Vision Locator. Successful use of the Verifier/Vision Locator depends on good locating skills and correct understanding of receiver response.

GENERAL SAFETY

 **DANGER** : Do not attempt to connect to Live Power without proper protective Equipment and Training.

 **DAGER ELECTRIC SHOCK** : Death or serious injury will result
NOTICE : Do not apply more than 250 volts across clips. More than 250 volts will damage transmitter.

⚠ DANGER : High Voltage. Cutting high voltage cable can cause DEATH or ELECTROCUTION. Expose lines by a non-destructive means before excavating.

⚠ DANGER : Traffic Hazards can result in death or serious injury. Avoid moving Vehicles. Wear high-visibility clothing.

⚠ WARNING : Buried lines. Always confirm your depth estimate by exposing target line by a non-destructive means.

⚠ WARNING : Jobsite Hazards can cause DEATH or SERIOUS INJURY. Wear proper safety equipment.

NOTICE : Non-metallic lines can be accurately detected only by using a probe. Remember this before searching and attempting any excavation activity.

NOTICE : Use only alkaline batteries in the Verifier/Vision receiver and transmitter. Batteries contain acid, which may leak if the batteries are allowed to remain in The equipment when low or completely discharged. This acid can cause Equipment damage.

2. Introduction

This equipment is the high performance digital measurement equipment to measure the location and the depth of buried cable / metal pipe from the ground. By adopting the most recent microcomputer technology, the digital correction of the measurement data realizes stable and high precious measurement.

- Principle measurement method -

When current flows through a buried cable/pipe, an alternating magnetic field is generated around it. Location, depth, and current value of the buried pipe can be measured using the Receiver at the surface of the ground.

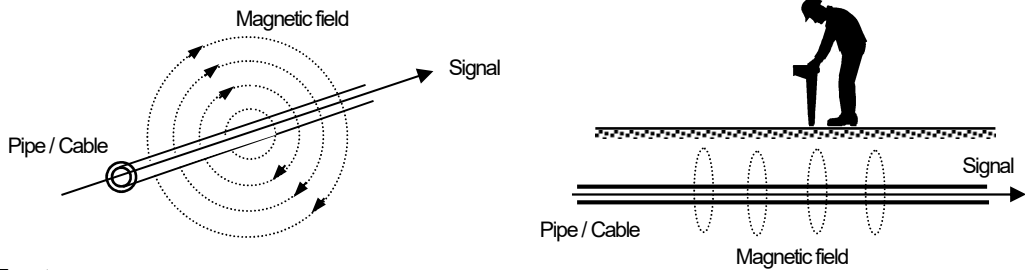

- Feature -

- Adopting the differential coil method allows the Receiver to receive the signal from directly below the Receiver by **reducing** noise from surrounding area.

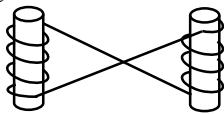

*The model figure of the differential coil.

The differential coil method connects two coils. Signal is then compared inversely between each coil.

- Three kinds of the location measurement mode (having error detection protection function)
 - *Peak & Null mode: The method to detect maximum and minimum sensitivity simultaneously.
 - *Peak mode: The method to detect maximum sensitivity.
 - *Null mode: The method to detect minimum sensitivity point indicated with arrow.

User operation is not needed.

Yaw angle, Depth of buried pipe and Current Measurement are continuously displayed when using all location modes.

- Two types of the depth measurement modes
 - *0-5m (16ft) mode: Measurement of depth with high precision is possible in indirect method, at the end of a cable, and jointing points.
 - *0-10m (30ft) mode: Stable measurement is possible at deep depths, near guardrail, or fence. Do not use this mode when in inductive mode.
- The Receiver can measure commercial frequency (50/ 60 Hz, 100 / 120 Hz) and Radio (from 9k to 33 kHz) without the use of the Transmitter.
- The best-suited frequency is automatically selected in-radio mode (9k – 33 kHz) with **search function**.
- The measured data is stored (maximum 400 data) with **one-touch operation**.
The data can be transmitted to a PC as standard function. (PC software and PC cable are option.)
- Broadcasting of four frequencies (512 Hz, 9.5 kHz, 38 kHz, 80 kHz) as needed for various buried utilities.
- A Probe as an option can be used to detect non-metallic pipe.

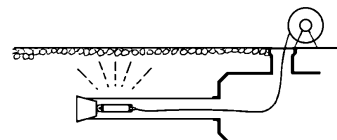

3. Composition

3-1. Main equipment & standard accessories

Description	Q'ty	Remark
Transmitter Unit	1pc	Used as a signal generator.
Receiver Unit	1pc	Digital locator
<i>Accessories</i>		
38kHz External coil	1pc	Used for External coil mode
Connecting cable	1pc	Used for Direct connection mode
Ground rod	1pc	Used for Direct connection mode
A-Frame	1pc	With 1.5m/5ft. cable
Operating manual	2pcs	English version

3-2. Optional equipment

Description	Q'ty	Remark
9.5kHz External coil	1pc	Used for External coil mode.
80kHz External coil	1pc	Used for External coil mode.
Sewer Probe	1pc	Used for non-metallic pipe. Standard probe for 75mm/ 3" & 100mm/ 4" pipe. Frequency: 38kHz or 512Hz
Mini probe	1pc	For 25mm / 1" fiber optic duct. For tracking non-directional drilling tools. Frequency: 38kHz , 512Hz, 850Hz
PC Interface Cable	1pc	Provided as USB cable
Data viewer software	1pc	Provided on the CD
Earphone	1pc	Used in a noisy area.
Carrying bag	1pc	

4. Specification

Transmitter (TX)

Output frequencies	38 kHz :38 kHz±0.02% (Standard frequency) 9.5 kHz :9.5 kHz±0.02% 80 kHz :80 kHz ±0.02% 512 Hz :512 Hz ±0.02% (Direct connection mode ONLY) Dual :9.5 kHz /38 kHz±0.02% (Direct connection mode ONLY) FF :9.5 kHz /512Hz±0.02% (Direct connection mode ONLY)
Output power	5 watts maximum / 80kHz: 1 watts maximum
Operating Modes	Direct connection External coil mode (optional)
Battery type	Eight Alkaline LR20 “D”
Battery Life	Direct mode : 50 hours (Output 4 mA, 20°C / 68°F) Inductive mode : 20 hours (Output 50%, 20°C / 68°F) Full Power(5W) : 10 hours (20°C / 68°F)
Battery Status	Low battery indication & Press key readout
Visual Indication	LCD : Bar graph & Digital number, includes Backlight
Audio Indication	Internal Speaker : Alarm, Beeping sounds
Measuring function	Output Current : 0 to 300mA Line Voltage : 0 to 250V
Output protection	AC 250V (512Hz: Output is cut off automatically)
Operating Temperature	-20°C to 50°C / -4°F to 122°F
Dimensions	When using: 261 x 314 x 110 mm(10.3" x 12.4" x 4.3") When storage: 227 x 314 x 110 mm(8.9" x 12.4" x 4.3")
Weight	3.6 kg/ 7.9 lbs. approx. including eight batteries

Receiver (RX)

Active Frequencies	38 kHz	: 38 kHz $\pm 2\%$
	9.5 kHz	: 9.5 kHz $\pm 2\%$
	80 kHz	: 80 kHz $\pm 2\%$
	850 Hz	: 850 Hz $\pm 2\%$
	512 Hz	: 512 Hz $\pm 2\%$
Passive Radio	RAD	: 9 k to 33 kHz (80 bands)
Passive Power	POW	: 45~65 Hz
	120 Hz	: 95~125 Hz
Battery type	Six Alkaline LR6 "AA"	
Battery Life	18 hours (20°C / 68°F)	
Battery Status	Continuous indication	
Power save function	Automatically power off after 5minutes of inactivity	
Visual Indication	LCD : Bar graph , Digital number & character, include Backlight	
Depth Display Range	High precision depth measurement	
	Line: 0 to 5 m /16 ft. (0-5 m / 0-16 ft. mode)	
	0 to 10 m /30 ft. (0-10 m / 0-30 ft. mode)	
	Probe : 0 to 10 m /30 ft.	
	Real time depth measurement	
	0 to 9.9 m / 33ft.	
Depth Readout Unit	Meter / Feet & Inch	
Depth Accuracy*1	2.0m / 6.5ft.	: $\pm 2.5\%$
	3.0m / 10ft.	: $\pm 5\%$
	5.0m / 16.5ft.	: $\pm 10\%$
Current value	Current value flowing on the conductor is displayed for line identity in milliamps.	
Audio output	Internal Speaker with sound volume adjusting function, Earphone (optional)	
Data logging	Memorized 400 points of the depth/ the current measurement/ the date and time data.	
Interface	6-pin output connector	
Operating Temperature	-20°C to 50°C / -4°F to 122°F	
Dimensions	660 x 130 x 270 mm (26.0" x 5.1" x 10.6")	
Weight	2.1 kg / 4.7 lbs. approx. including six batteries	

Note: *1 Locators are tested in test field conditions with no adjacent signals.

Always excavate the line with non-destructive means before digging.

*2 Optional cable is necessary to read the logging data.

5. Description of parts & basic operation



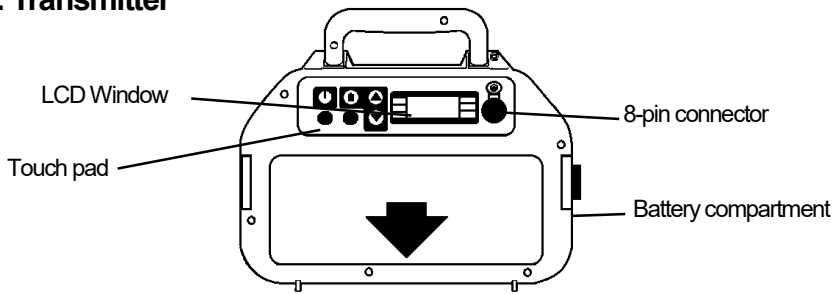

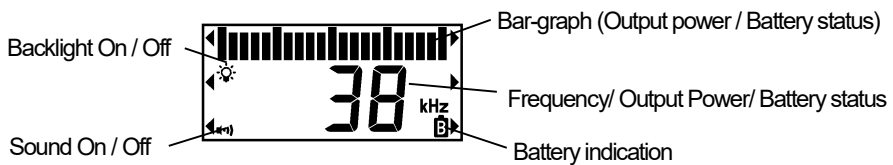

5-1. Transmitter





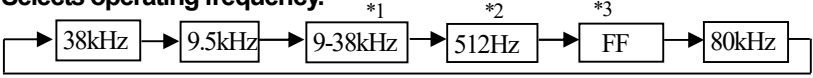









1) LCD window



2) Key function

 POWER	Power ON / OFF *Each time Transmitter is turned on the batteries are automatically checked.
 ADJUST	Press ADJUST key after hook up to automatically adjust power.
 FREQUENCY	Selects operating frequency.  <p>*1 9-38kHz : Broadcasts dual frequencies simultaneously in direct mode only. *2 512Hz : Direct mode only *3 FF : Fault finding signal for A-Frame.</p>
 MODE	Battery indication  *The B symbol appears when battery is low.
	Increase Output power
	Reduce Output power

 MODE	 	Light On/Off set : Press  key while holding  (MODE). <div style="display: flex; justify-content: center; align-items: center; gap: 20px;"> <div style="border: 1px solid black; padding: 2px 5px;">* L-1</div> ↔ <div style="border: 1px solid black; padding: 2px 5px;">L-0</div> </div> <div style="display: flex; justify-content: space-around; width: 100%;"> Light On Light Off </div>
	 	Sound set : Press  key while holding  (MODE). <div style="margin-bottom: 5px;"> <div style="border: 1px solid black; padding: 2px 5px;">b-2</div> : SOUND ON  </div> <div style="margin-bottom: 5px;"> <div style="border: 1px solid black; padding: 2px 5px;">b-1</div> : TRANSMITTER SOUND OFF, FUNCTION SOUND ON </div> <div style="margin-bottom: 5px;"> <div style="border: 1px solid black; padding: 2px 5px;">b-0</div> : SOUND OFF. </div> <p style="margin-top: 5px;">Press and hold  &  for 2 seconds.</p>

Note : The last setting is memorized after the unit is Turned OFF

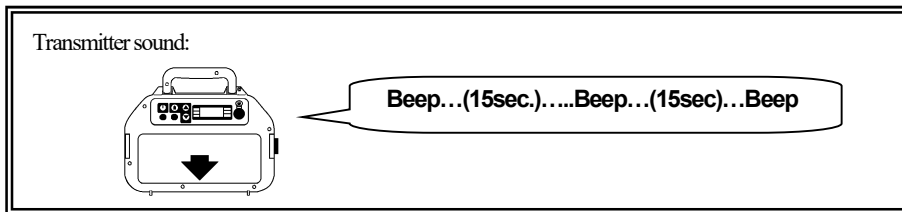

3) 8-pin connector

The Direct connection cord or the External coil cord are plugged into the 8-pin connector.

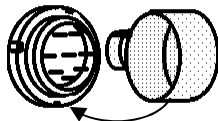

Put the rubber protector on when not in use.

4) Battery compartment

Replace all batteries when there is a low battery condition.



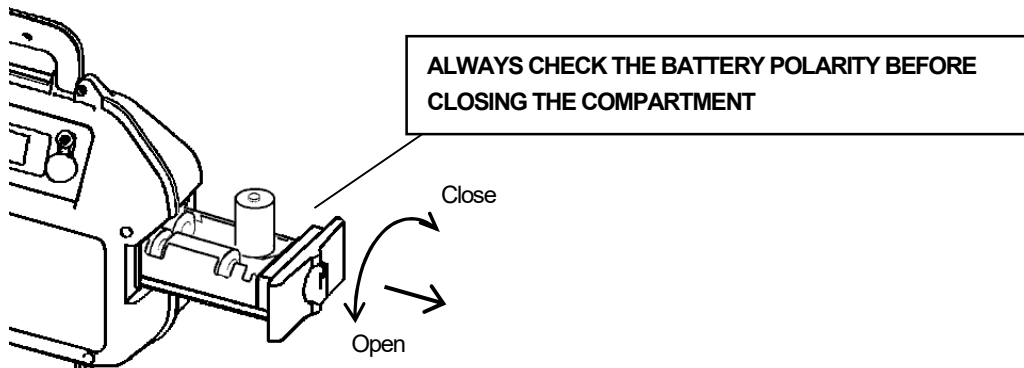



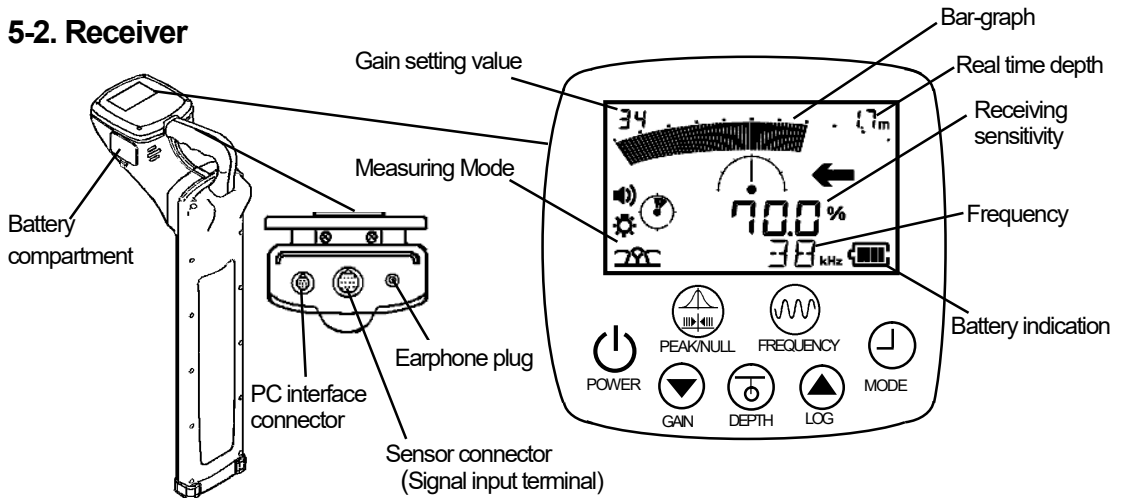

Use Eight 1.5V alkaline type D (LR20 / 13A) batteries.



5-2. Receiver











1)Key function

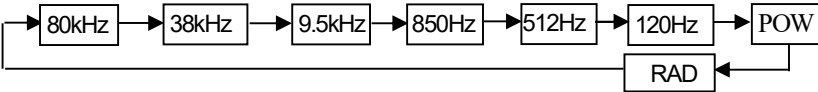

 POWER	Power ON / OFF *Power save function: Automatically powers off after 5~30 minutes of inactivity.
 LOG  GAIN	Adjusts signal sensitivity for PEAK MODE. * Manual gain control mode (MANU GAIN) Press the ▼Gain key, sensitivity is decreased. Press the ▲Log key, sensitivity is increased. * Semi-Automatic gain control mode (AUTO GAIN) When pressing the Gain key, sensitivity is adjusted automatically to 70%. <div style="border: 1px solid black; padding: 5px; margin-top: 10px;"> Note: 100% is not the maximum peak value. When 100% appears, press Gain key again until a new sharp peak value is obtained, that is not 100%. </div>
 DEPTH	Depth measurement (High precision): Press DEPTH key at the peak value spot. <div style="display: flex; align-items: center;"> <div style="border: 1px solid black; padding: 5px; margin-right: 10px;"> 2.47m 103.5mA </div> <div> Depth Current index: Details page 26 Note: Current index is not displayed if probe is used. </div> </div>
 PEAK/NULL	Selects locating mode: <div style="text-align: center;">  →  →  NULL PEAK PEAK & NULL ← </div>

PEAK & NULL MODE: Maximum sensitivity is the point directly above the object line and the buried object line location is indicated with arrow.

PEAK MODE: Maximum sensitivity is the point directly above the object line.

NULL MODE: Minimum sensitivity is the point directly above the object line. The buried object line location is indicated with arrow.

 FREQUENCY	<p>Selects operating frequency.</p> 									
 MODE	<p>Various settings</p> <p>1. Selects backlight options. By pressing Mode, continue on.</p> <p>Press ▼Gain : Select backlight On / Off. { LITE On  LITE OFF</p> <p>2. Selects sound options. By pressing Mode, continue on.</p> <p>Press ▼Gain : Select speaker sound On / Off. { SPK OFF  SPK On - 1 (Small)  SPK On - 2 (Large) </p> <p>3. Selects Depth function. By pressing Mode, continue on.</p> <p>Press ▼Gain : Select depth function 0-5m / 0-10m (0-16ft / 0-30ft).</p> <table border="1" data-bbox="391 846 1168 956"> <tr> <td>*0-5m / 16ft : Applied for Inductive mode. Detecting near the end of the pipe. Depth measurement range 0 to 5m(16ft).</td> <td>↔</td> <td>*0-10m / 30ft : Applied for the depths deeper than 5m(16ft), near guardrail or metal fence. The measurement range of depth 0 to 10m(30ft).</td> </tr> </table> <div data-bbox="391 981 1163 1124" style="border: 1px solid black; padding: 5px;"> <p>⚠ CAUTION</p> <p>When applying Inductive mode, select 0-5m / 16ft . Depth measurement error increases near the Transmitter when 0-10m/30ft is applied.</p> </div> <p>4. Selects Gain control operation. By pressing Mode, continue on.</p> <p>Press ▼Gain : Select Gain control operation GAIN { MANU (See page 9) AUTO</p> <p>5. Selects PROBE detection. By pressing Mode, continue on.</p> <p>When Sewer or Mini Probe is employed for the detection of Non-metallic pipe or Boring device, 38kHz, 512Hz and 850Hz are used for Probe.</p> <p>Press ▼Gain : Select detecting</p> <table border="1" data-bbox="747 1362 1104 1477"> <tr> <td>"No icon"</td> <td>↔</td> <td></td> </tr> <tr> <td>PRB OFF Cable / Pipe detection</td> <td></td> <td>PRB On Probe detection</td> </tr> </table> <p>6. Select real time depth and current displaying in Peak-mode. By pressing Mode, return to measurement.</p> <p>Press ▼Gain : Select ON/OFF. { D / CU On : Real time <u>D</u>epth and <u>C</u>urrent are displayed. D / CU OFF</p> <p>*When location mode is null or peak & null, real time depth and current are always displayed regardless of this setting.</p> <p>*The last setting is saved except Depth and PROBE function.</p>	*0-5m / 16ft : Applied for Inductive mode. Detecting near the end of the pipe. Depth measurement range 0 to 5m(16ft).	↔	*0-10m / 30ft : Applied for the depths deeper than 5m(16ft), near guardrail or metal fence. The measurement range of depth 0 to 10m(30ft).	"No icon"	↔		PRB OFF Cable / Pipe detection		PRB On Probe detection
*0-5m / 16ft : Applied for Inductive mode. Detecting near the end of the pipe. Depth measurement range 0 to 5m(16ft).	↔	*0-10m / 30ft : Applied for the depths deeper than 5m(16ft), near guardrail or metal fence. The measurement range of depth 0 to 10m(30ft).								
"No icon"	↔									
PRB OFF Cable / Pipe detection		PRB On Probe detection								

 MODE	<p>Setting the Time and Date</p> <p>a) Power on while holding Mode, wait for clock display appears.</p> <p style="padding-left: 20px;">The year will flash.</p> <p style="padding-left: 20px;">Press ▼Gain to advance the year or ▲Log to decrease the year.</p> <p>b) Press Mode, the month will flash.</p> <p style="padding-left: 20px;">Press ▼Gain to advance the month or ▲Log to decrease the month.</p> <p>c) Do same as above to set Day --> Hour --> Minute.</p> <p style="padding-left: 20px;">When measurement starts, setting is completed.</p>	
--	---	---

2) Battery compartment

Replace all batteries when there is a low battery condition.
 Use six 1.5V alkaline type AA (IEC LR6/NEDA15A).

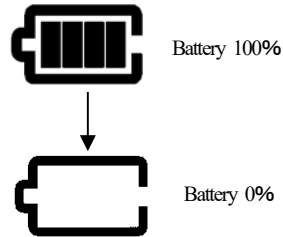
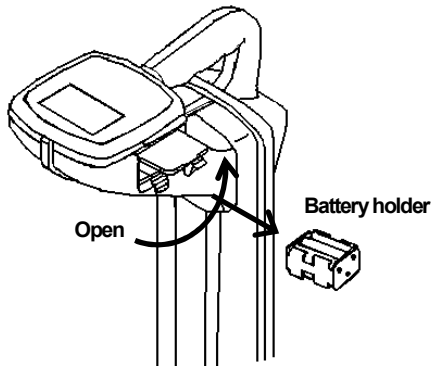

ALWAYS CHECK THE BATTERY POLARITY BEFORE CLOSING THE COMPARTMENT

3) PC interface connector

The connector is used to communicate PC and GPS.
 *Interface cable & GPS are supplied as option.

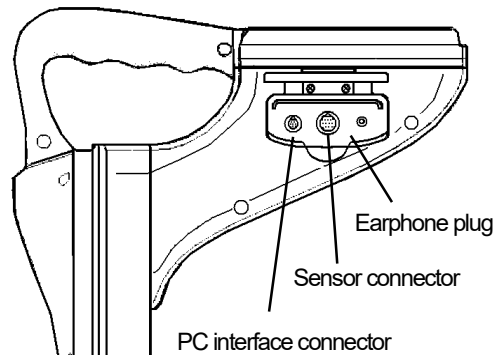

4) Earphone plug

Earphone can be used in a noisy area.
 Supplied as an option.

5) Sensor connector (Signal input terminal)

Used with A-Frame or Sensor coil.
 Sensor coil is supplied as options.

6) Digital level

Displayed the inclination of the receiver.

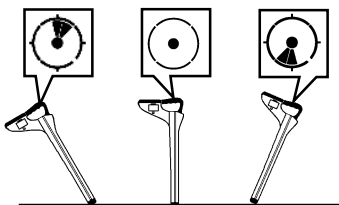

Calibration methodology of digital level

- a) Power on while holding **Depth** key.
PUSH GAIN is indicated in 1 seconds.
- b) Hold the receiver in vertical position: (center of left chart)
- c) Press **▼GAIN**. Please do not move the receiver until **OK** is displayed.
- d) Press **▼GAIN** again. Incline the receiver to the front, back, left and right, and confirm the display.
 The setting is memorized with Power off.

6. Warning Message

*Messages during your search procedure :

OVER	<p>Receiving signal is too high.</p> <p>a) Indirect mode : Transmitter and Receiver are too close each other. b) Other options: Reduce output of the Transmitter.</p>
LOW	<p>Receiving signal is too weak or not present.</p> <p>a) In the case of direct, induction or coil</p> <ul style="list-style-type: none"> - Increase output of the Transmitter. - Check batteries, connecting parts and frequency of the Transmitter. - Check signal loop at the Transmitter. <p>b) In the case of Radio / Power mode</p> <ul style="list-style-type: none"> - There are no conductors to radiate magnetic fields. There is no pipe or cable - There is a conductor, but the signal is too low to adhere to the line. Use Transmitter to search for the line.

*Messages on location :

PUSH GAIN	<p>Press GAIN key. ⇒ Normally this is your object line. Reduces or increases signal strength.</p>
----------------------	---

*Messages on Depth measurement :

ERR	<p>a) Received signal level is unstable, or received signal is too weak. b) Located point is not directly above the object line. c) Metallic fences, metallic structures or cars are interfering with the depth measurement. Find area with less interference. d) The Line is disconnected.</p>
16. -ft/in.	<p>Indicating that the depth measured is deeper than 5 m / 16 ft. In Line detection (0-5m / 0-16ft.) mode, locator cannot read below this depth</p>
5. -m	

7. Operation of Transmitter (TX)

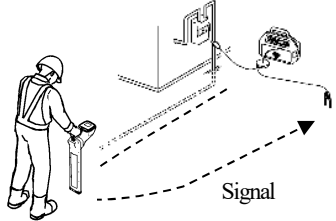
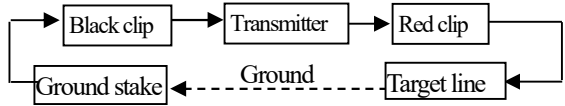
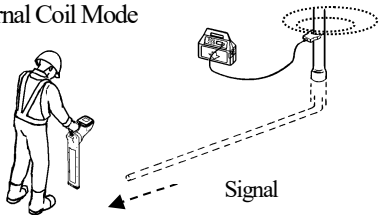
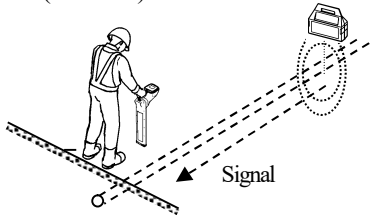
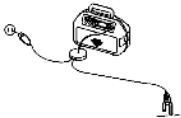
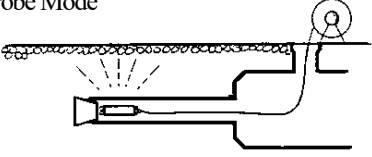
Mode of Detection	Purpose of usage
<p>Direct Connection Mode</p> 	<p>This is the best way to inject AC current directly to the target line. Signal (AC current) will return to the Transmitter through the ground.</p>  <p>Effective for detecting the target line in congested areas.</p>
<p>External Coil Mode</p> 	<p>Advantage for live power or cable, that is not accessible for Direct connection. The clamp is waterproof and will attach on any size cable or conduit. No need for a ground stake. Effective for detecting the target line in congested area. The target line must be grounded.</p>
<p>Indirect (Inductive) Mode</p> 	<p>If there is no direct access to the target line, use this method. The Transmitter can induce its signal to the buried line. Place the Transmitter in an upright position and at right angle to the buried line.</p> <p>Minimum TX to RX distance \Rightarrow 30 ft. / 10 m</p> <p><i>Note: When using the indirect mode, set the depth mode of the receiver to 0-5m (0-16ft.). Depth measurement error increases near the Transmitter when 0-10m (30ft) is applied.</i></p>
<p>Building Wiring</p> 	<p>Used with Connecting cable to find wiring systems in the building. TX's circuit is protected* up to 250V at 50 / 60 Hz.</p> <p>*If using the low frequency (512Hz,...), output is cut off automatically for protecting the unit.</p>
<p>Probe Mode</p> 	<p>Used for tracing small diameter drains or plastic pipes. Also, pinpoint a drain blockage or collapse. Can trace non-directional boring tools. The Probe is available in two sizes 20mm/ 0.79" and 50mm / 2" diameter.</p>

7-1. Direct connection mode

A specific route can be detected in Direct Connection mode. Use two 5m/16.5 ft. connecting cables on a reel provided in the carrying case as one of the standard accessories.

When the clips are connected to the transmitter, Direct Connection mode automatically selected.

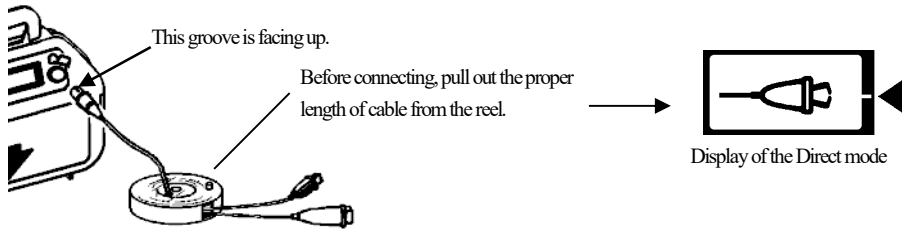

Frequency setting

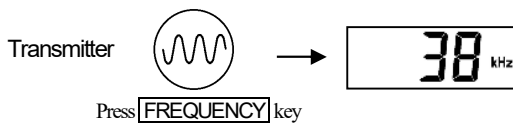

*Set a receiving frequency on the Receiver the same as the transmitter.

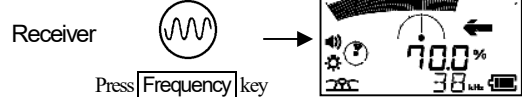

Connect the cable clips to the target line and ground stake.

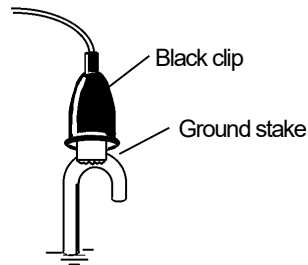
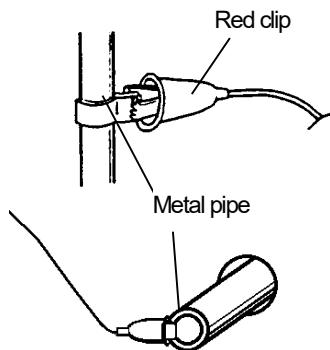

Note: Clean connection area if rusted or painted to ensure a good electrical connection.

Check the grounded point. Find the best place to ground to have a GOOD SIGNAL LOOP indication.

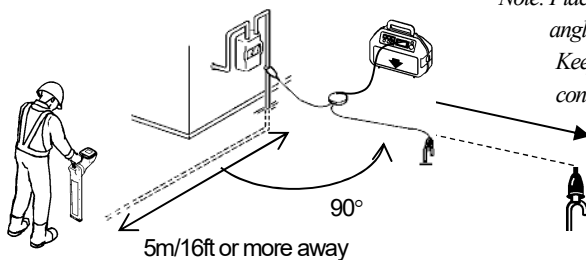

Note: Place the Earth/Ground as far as possible and at right angle to the object line.

Keep Receiver at least 5m/16ft. away from the signal connection point as illustrated

Check the signal loop

When signal loop is acceptable, Beeping sound is emitted.

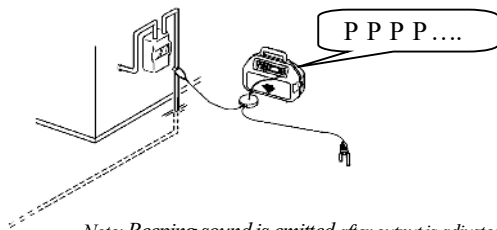

*Transmitter will beep for 30 seconds.

*Sound stops when Pressing the **ADJUST** key.

*Sound setting is [b-0] => Beeping sound off.

Note: Beeping sound is emitted after output is adjusted when the resistance value of the cable is high.

Adjust output power

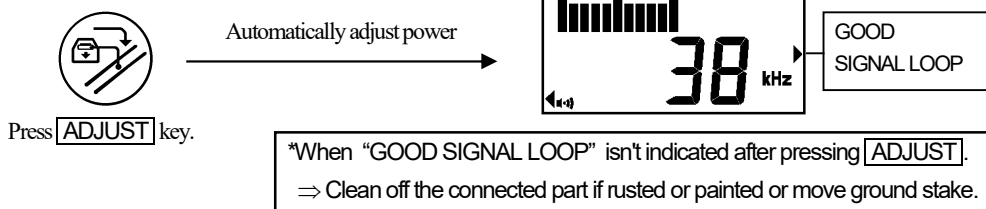

When output is adjusted

*When the Receiver indicates "OVER", Press  key. => Reduce output.

*When locating a long-distance line or deeper depth than 3m/ 16ft., Press  key. => Increase output.

Check the voltage when connecting clip to Power line.

- When voltage is greater than 20 volts, voltage is displayed.
- When voltage is greater than 25 volts, Alarm sounds.

Note: 512Hz output is cut off automatically.

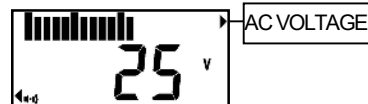
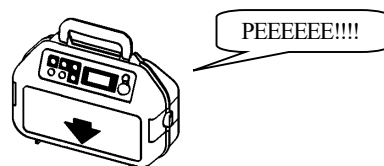

ELECTRIC SHOCK

Death or serious injury will result. 250 Volts maximum across clips. Use protective equipment.

Direct Connection mode

Use the Receiver 5m / 16ft. away from the transmitter and clips.

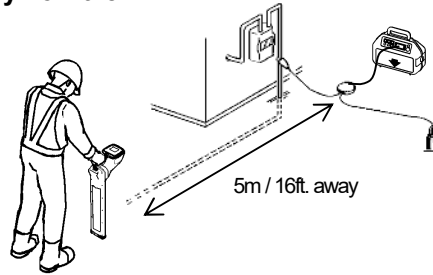

Applications (1)

Power cable:

Disconnect other utilities that maybe connected to the common ground lead and connect the Red clip to Power line ground lead. Then locate Power line.

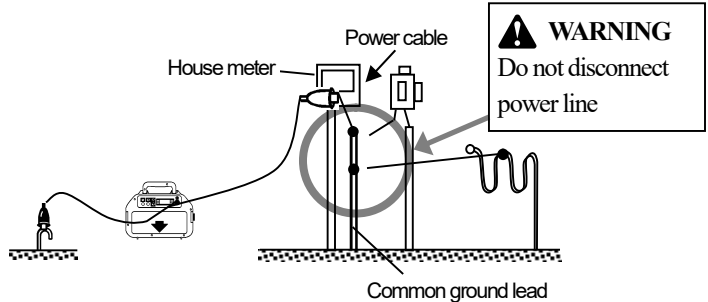

Telephone cable:

Disconnect Telephone Ground lead and connect the Red clip to it to locate Telephone line.

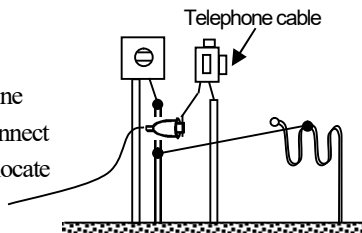

CATV cable:

Disconnect CATV's ground lead and connect the Red clip to it to locate CATV line.

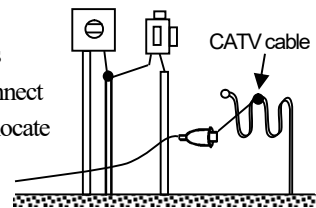

WARNING

Remember to correctly reconnect common grounds for telephone & CATV.
Check Local codes for proper grounding procedure. IMPROPER GROUNDING MAY CAUSE DAMAGE TO APPLIANCES, FIRE OR EXPLOSIONS.

Applications (2)

If the dead cable is the object, connect the red alligator clip of the connecting cable to either the aluminum-sheath or a bundle of the copper cores directly.

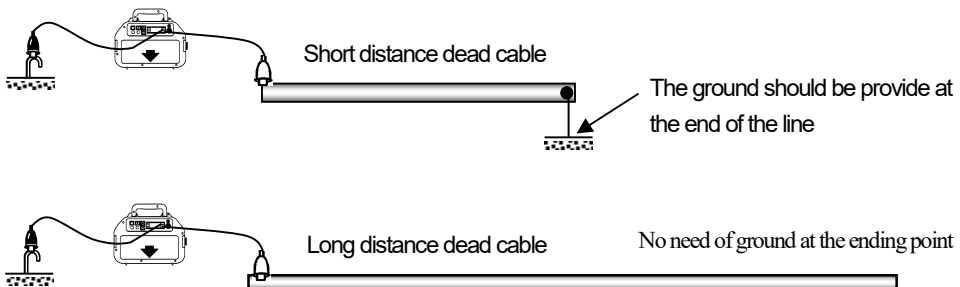

7-2. External coil mode

Use 9.5 kHz, 38 kHz or 80kHz External coil supplied as an option. Use this mode if object is accessible. An induced current, generated by the coil in the External Coil attachment, is applied directly to the exposed part of the cable / pipe to be located.

Applicable to : Live Telecom cable or Live Power cable. Fiber optic cable having an aluminum-sheath.

When the External coil is connected to the transmitter, External coil mode is automatically selected.

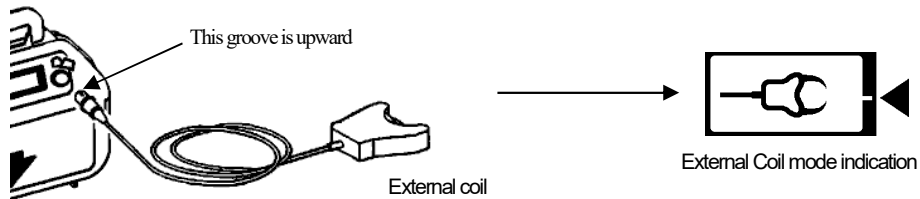

Frequency setting

Frequency is selected based on coil used with the External coil automatically.



*Set a receiving frequency on the Receiver the same as the transmitter.

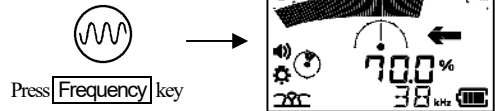

Adjust output power

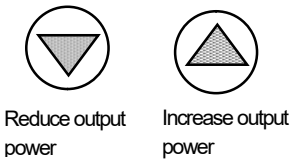

Indicate output power with the bar graph and the numerical value when pressing ∇ / \blacktriangle key.

*If the output is adjusted to over 70%, it is automatically set to 70% when power off.

Connect the External coil to the target line.

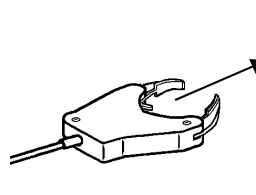
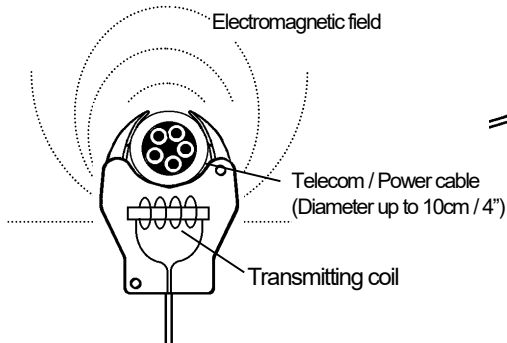

*The jaws do not have to be closed around the cable.

(This coil method is different from the conventional clamp that must have jaws perfectly closed. Different size clamps are not needed. This coil method uses Indirect / Inductive principle.)

Note :Make sure it is attached parallel and in line with the cable as illustrated.

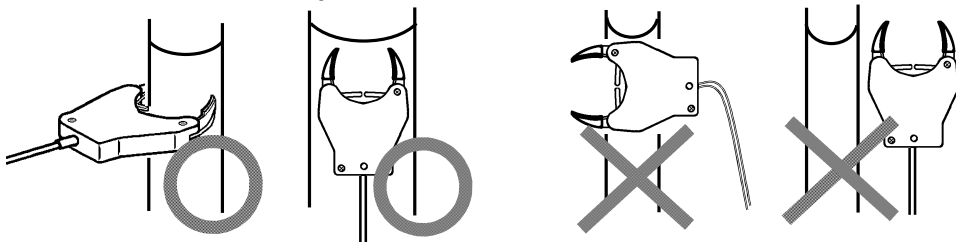

External coil mode

**Make sure that the cable is grounded at both ends.
Do not put the coil close to or around the ending or middle ground.**

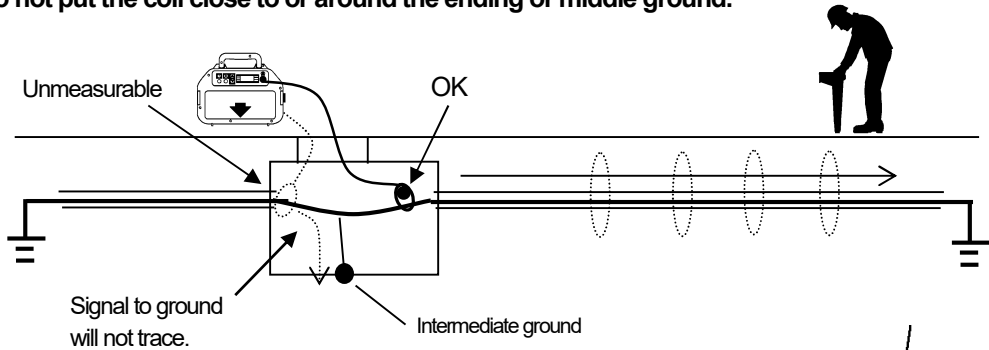

* If the cable is submerged in water, you can use the coil attachment in the water.
The coil attachment is **WATERPROOF**.

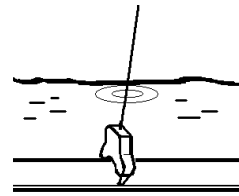

*Note : Fresh water has no effect Locating the cable or detecting depth.
Brackish or salt water will effect locating.*

**Note : Do not attach to the metal pipe or metal riser above the ground.
Attach the coil clamp to the cable/PVC part.**

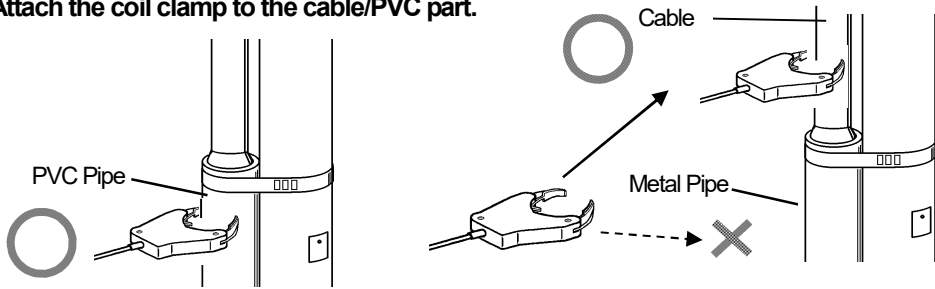

Note :Use the Receiver more than 5 m/16 ft away from the coil clamp when starting the location work.

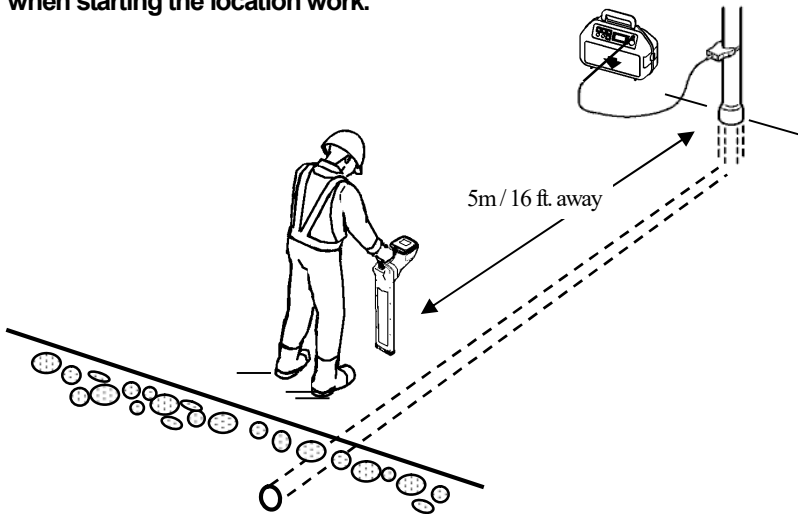

7-3. Indirect (Inductive) mode

If there is not direct access to the object line, the Transmitter can apply AC current (signal) to the line directly below the Transmitter.

Note: When using the indirect mode, set the depth mode of the receiver to 0-5m (0-16ft.) .

When nothing is connected to the transmitter, Indirect mode automatically selected.

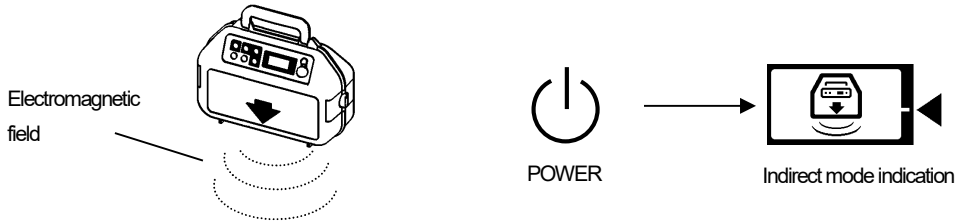

Frequency setting

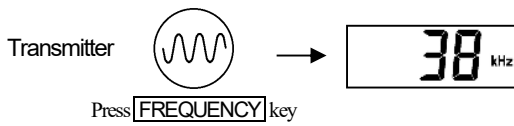

*Set a receiving frequency on the Receiver the same as the transmitter.

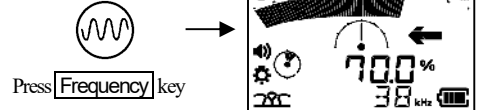

Place the transmitter over or near the area of the measuring object.

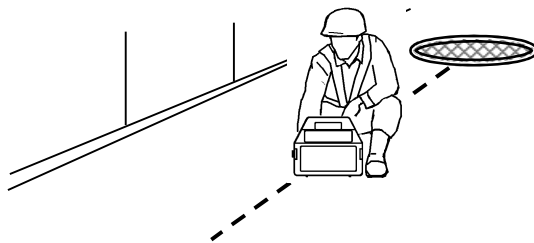

Do not place the Transmitter on a manhole cover or other steel covering.

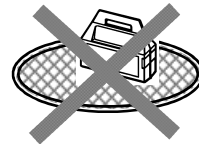

***Place the Transmitter in an upright position at a 90° angle to the object line as illustrated.**

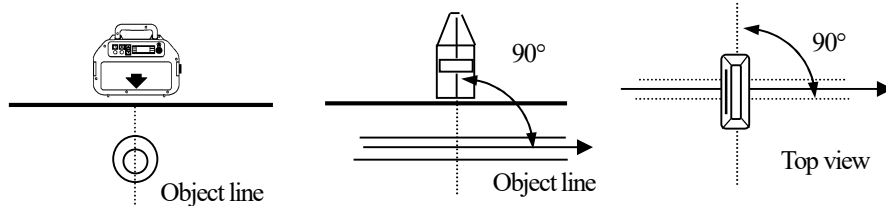

***Location near the area of a manhole, place the Transmitter on the side of the manhole you wish to locate.**

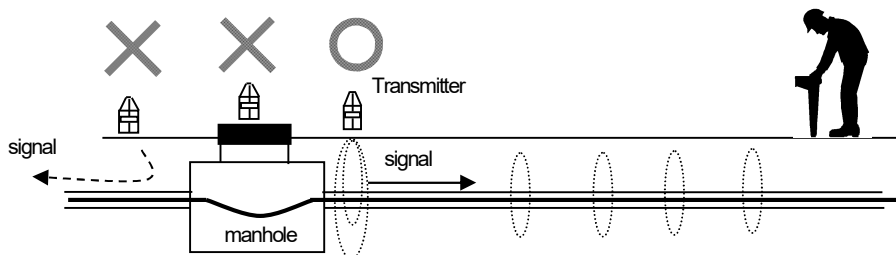

Indirect mode

Adjust output power



Reduce power



Increase power



Indicate output power with the bar-graph and the numerical value when pressing / key.

*Standard of adjustment.

- When depth is less than 0.6m / 2ft. \Rightarrow 50% ~ 60%
- When depth is more than 0.6m / 2ft., less than 1.5m / 5ft. \Rightarrow 70% ~ 80%
- When depth is more than 1.5m / 5ft. \Rightarrow 90% ~ 100%

*Note: If output is adjusted to 100%, you can usually locate in any area.
But the battery of the transmitter is reduced as output increases.*

Note :Use Receiver more than 10m / 30ft. away from Transmitter when starting the location work or an "Air Coupling" between the Transmitter and Receiver can exist.

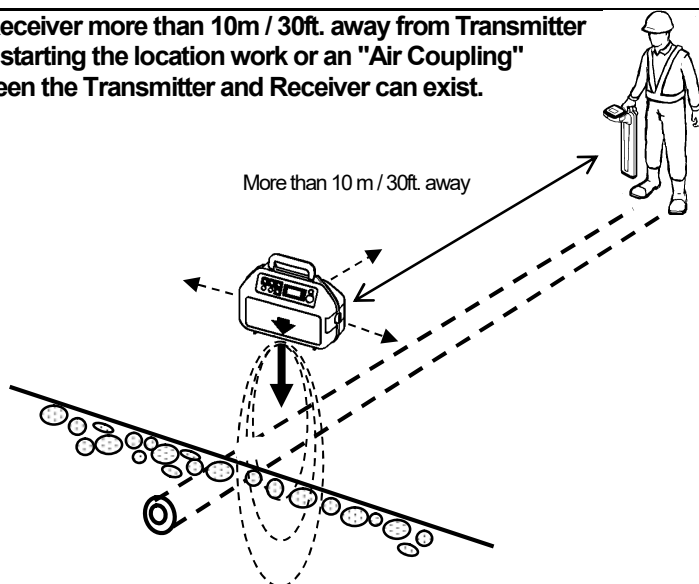

Note: Detection of the Multiple Telephone Cable Pipes (Metal Ducts) in Indirect mode

Don't assume that the peak point of the signal strength obtained is the center of the multiple lines.
It is the central point of the electromagnetic field applied by the Transmitter.

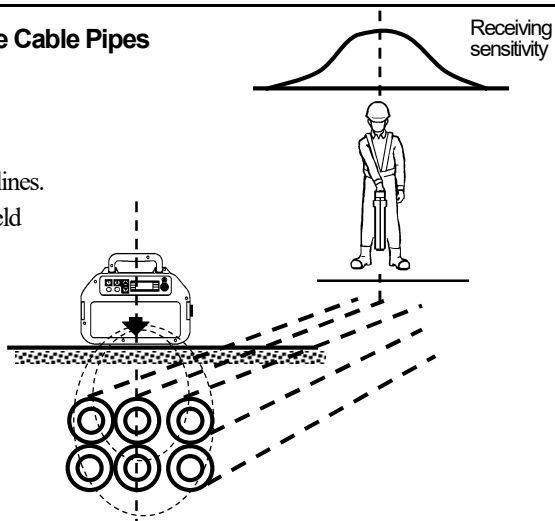



8. Operation of Receiver (RX)

Tutorial

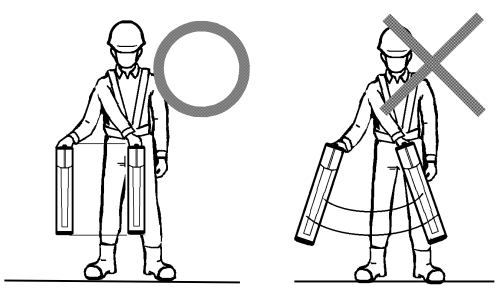
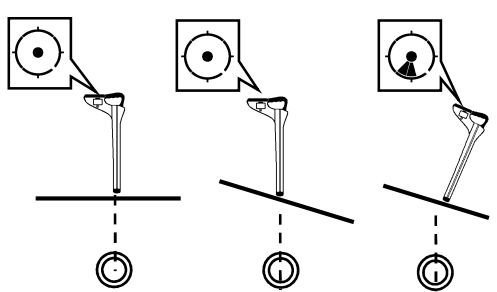
Basic of the measurement.

<p>Move the Receiver from side to side to determine the exact position.</p>  <p>Pinpoint the position.</p> <p>Do not swing like this.</p>	<p>Hold the Receiver perpendicular to the ground.</p> <p>Use the DIGITAL LEVEL.</p> 
--	--

Measurement Mode

	PEAK & NULL MODE	PEAK MODE	NULL MODE	Functional Description
Icon				
Bar Graph	PEAK	PEAK	NULL	Display the graph detecting right above the cable
Sensitivity Indication	0 – 100%	0 – 100%	0 – 9999	Indicate the receiver sensitivity
Left and Right direction display	YES	NO	YES	Display the direction by left and right arrow
YAW angle display	YES	YES	YES	Display the YAW angle
Continuous Depth measurement	YES	YES *See page 10	YES	Display the real time depth of the cable
Continuous Current measurement	YES	YES *See page 10	YES	Display the current value of transmitting signal
Purpose	Various uses	Simple operation	Route searching Using around the metal objects	

*Use the Depth Key when measuring the depth of the buried pipe more accurately

8-1. Peak & Null mode

Starting Peak & Null Mode

Press **PEAK / NULL** key. → Select peak & null

To find the direction of the object line, using the Yaw Angle Display.

Direction of the buried cable.

To find the position of the object line

Maximum (peak) value, the precise position and direction, are obtained when the receiver blade is located on the top of the object line

OUT OF RANGE Percentage of the receiving level is not indicated.

0% 30% 70% 30% 0%

Move to the direction arrow

Distance is approximately same as depth

Distance is approximately same as depth

Buried Line

To adjust the sensitivity of the receiving level.

A) Manual gain control mode

Press the **Gain/Select** key, sensitivity is decreased.

Press the **Gain/Log** key, sensitivity is increased.

Gain setting value 0: minimum sensibility
99: maximum sensibility

B) Semi-automatic gain control mode

100% 100% 30% 30%

When 100% appears...

Press **Gain** key.

70%

50% 50%

70% appears as an initial receiving level.

When **PUSH GAIN** appears...

Note: 100% is not the maximum peak value.

8-2. Null mode

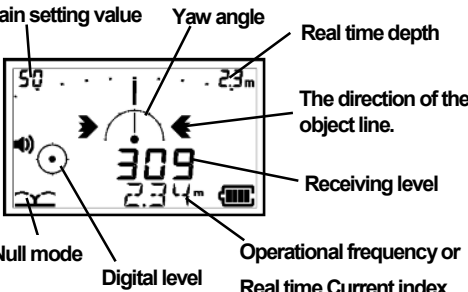
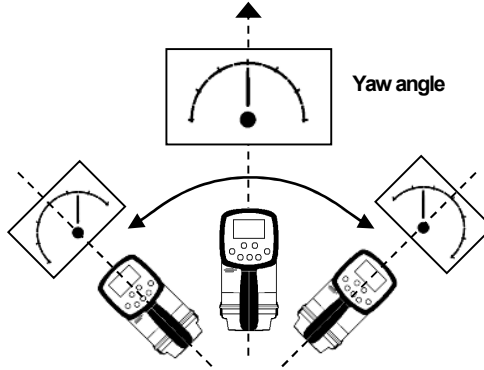
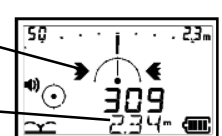
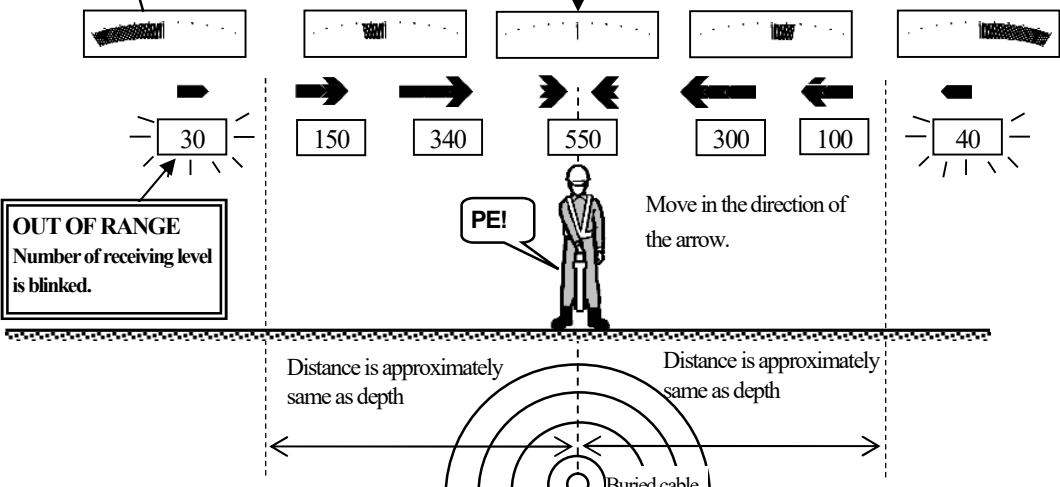
<p>Starting Null Mode</p> <p>Press PEAK / NULL key. →  Select null</p>  <p>Gain setting value Yaw angle Real time depth The direction of the object line. Receiving level Null mode Digital level Operational frequency or Real time Current index</p>	<p>To find the direction of the object line, using the Yaw Angle Display</p> <p>Direction of the buried cable.</p>  <p>Yaw angle</p>
<p>To find the position of the object line</p> <div style="border: 1px solid black; padding: 5px; margin-bottom: 10px;"> <p>TOP of the object line The arrows are indicated on the both side. Beep sound is emitted. Real time depth or current index is displayed on the bottom line.</p>  </div> <p>Bar-graph (Sensibility and L/R direction)</p>  <p>OUT OF RANGE Number of receiving level is blinked.</p> <p>PE!</p> <p>Move in the direction of the arrow.</p> <p>Distance is approximately same as depth Distance is approximately same as depth</p> <p>Buried cable</p>	

8-3. Peak mode

<p>Starting Peak Mode</p> <p>Press PEAK / NULL key. →  Select peak</p>	<p>Method of this Mode</p> <p>Peak mode is almost same as Peak & Null mode. The difference is that there are no Null functions. See the Peak & Null Mode Page 22. *Real time depth and current are displayed when "D /CU" setting is on. See page 10.</p>
---	--

8-4. Depth measurement (High precision)

Once the precise location of the object line has been determined, the **Depth** key is pressed to display the distance from the Receiver's blade to the object line. Calculations are indicated on the digital display.

Note: Depth reading is a calculation of received signal strength.

Hold the Receiver vertically, place the blade on the ground and **do not move it during the depth measurement.**

Touch the ground with the Receiver's blade at an upright position.

If the ground slopes, keep the Receiver at right angles to the axis of the globe.

Check the vertical condition of the locator by Digital level indicator.

Press **Depth** key.

DEP
38 kHz

***Warning message**

5.---m
38 kHz

16'---"
38 kHz

Deeper than 5m / 16ft.

LOW

OVER

Signal is too low / too high.

ERR

0-5
38 kHz

Indicate depth mode

3.78m
45.7mA

Depth

Current index

Data Logging Press **Log** key.

LOG 8

Data number

Memorized Depth, Current index, Date, time and frequency.

Press **Gain** key.

Start locating

Note: When setting is "MANU GAIN" (see page 9), to 5 seconds after depth value is displayed, the screen will return to the position locating automatically.

ERR appears...

*Receiving signal is not strong enough.

- Possibly this is the wrong line.
- Move the Receiver again from side to side to find the exact position.

*Gas pipe => if not well jointed



- injected signal does not travel well
- receiving signal is too low

How to select unit of the depth measurement



- 1) Power on while holding **PEAK/NULL** key. **DEP METE** or **DEP FEET** screen is indicated in 3 seconds.
- 2) Press **PEAK/NULL**, and select **METE** (meter) or **FEET** (feet).
- 3) The setting is memorized when Powered off.

8-5. Logging Data

Indicate the Logging data

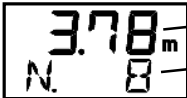
1) Press **Mode** key.  →  Backlight setting screen appears.

2) Press and hold **LOG** for one second.  →  Depth Data
Data number The data recorded at the end is indicated.

3) Press  - Increase data number. Press  - Decrease data number.

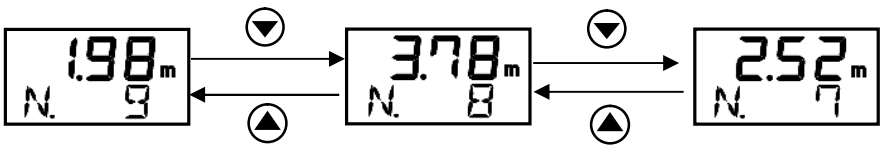



4) Two seconds after data is displayed., its stored date and hour is displayed automatically in order.



Delete Logging data



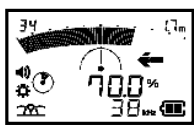

 **CAUTION: If delete operation is done, all data is gone.**

Press and hold **Frequency** key for two seconds. →  Takes several seconds to delete data. → 

Return to locator function

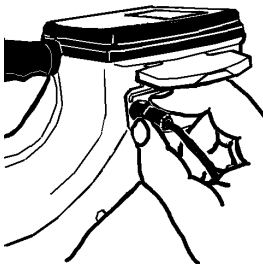
 Press **Mode** key. →  Return to locator function

Download data to the PC

 →  Press **Mode** key. →  Data communication screen appears.  Connecting mark

*Connect the PC interface cable to the 6-pin connector.
* PC interface cable is option.

Refer Data viewer software manual about operation of data communication with a PC.

8-6. Current index (Current measurement)

Each time a Depth calculation is taken, a Current Index simultaneously appears on the display.

What's the Current index?

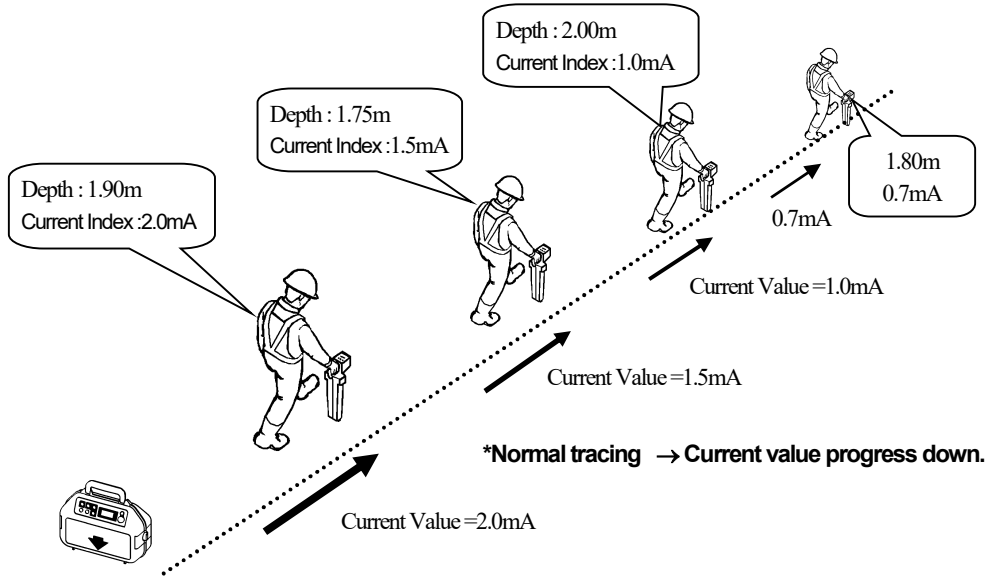

*The Current gradually reduces as the distance from the Transmitter increases.

When current suddenly drops...

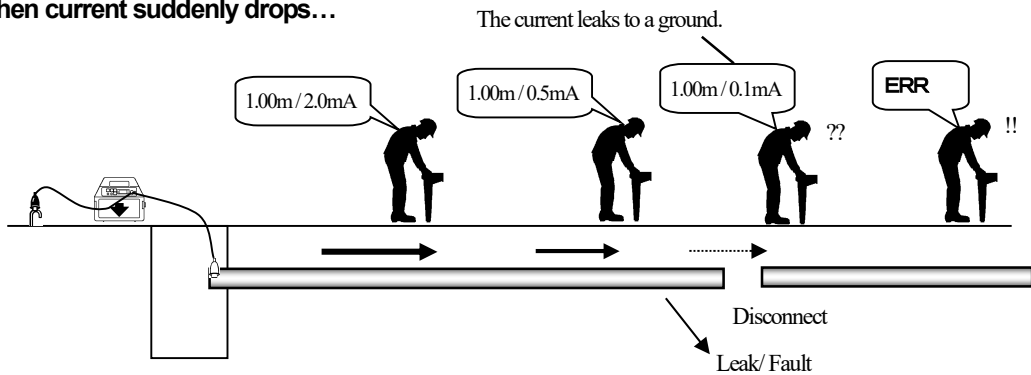

ERR : The line is disconnected.

Or, the current does not travel after the joint of the gas line / water line due to non-conductivity.

The Current value is not affected by the depth

The current value is not affected by the depth, but it is affected by the detection methods, the frequencies and power level.

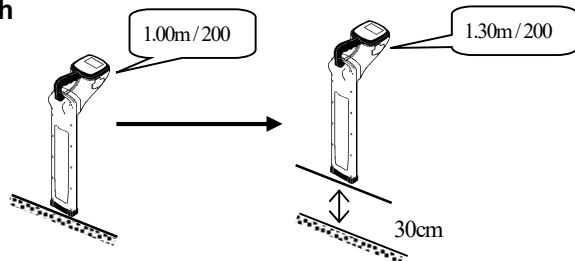

The Current index helps to confirm the line's identity.

If an adjacent line is running parallel with the object line.

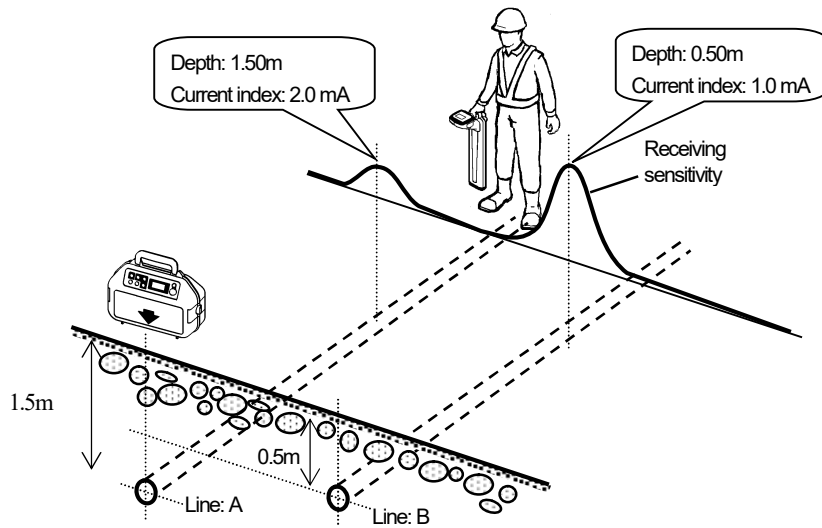

The line with the highest current index is the object line into which the signal is being broadcast.

⇒ Line A with a 2.0 mA current index is the trace object.

If two lines are crossing:

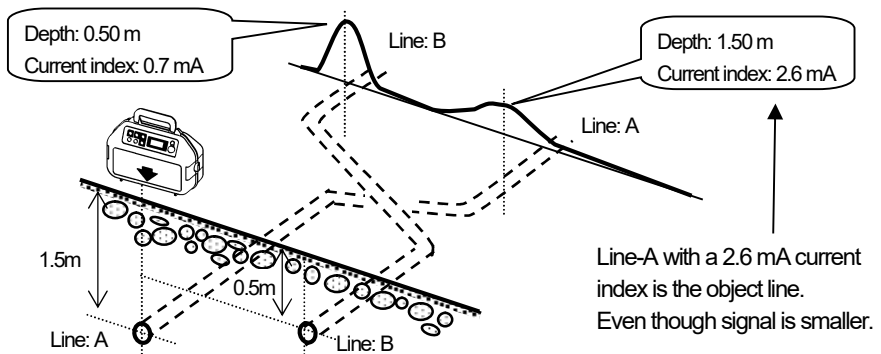

Locating T connection

⇒ Splicing/jointing points of Power cable, Telephone cable, Gas pipe, Water pipe, or Sewer pipe.

Main line-A with a 1.5 mA current index

→ Line-B: Index value 1.0 mA ⇒ Main line

→ Line-C: Index value 0.5 mA ⇒ Branch line

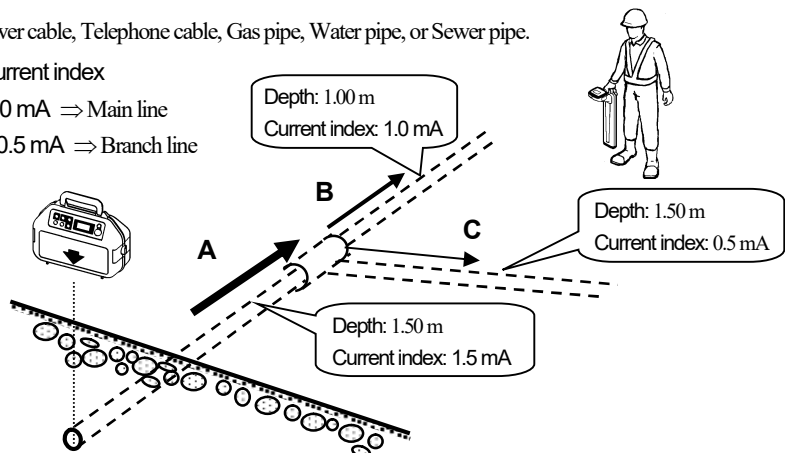

8-7. PASSIVE MODE

The Power and Radio passive modes of the Receiver are used to search an area for unknown power cables and other utility lines, without using the Transmitter.

Frequency setting



Press **Frequency** key.

Power mode: Power mode detects 50/60 Hz or 100/120Hz frequency radiated by the live power cable.

50Hz / 60Hz : select **POW**.

100Hz / 120Hz : select **120Hz**.

Radio mode: It locates buried utility lines as they reradiate very low frequency,

Select **RAD**.

Attention: Radio can only be selected when the peak mode or peak & null mode.

Auto search function of Magnetic field in environment (Radio wave)

When applying Radio wave (RAD) detection, the most sensitive frequency is selected with auto search function.

Search all frequencies

Set frequency to **RAD**, Press and hold **Gain** for one second. And then, search starts.

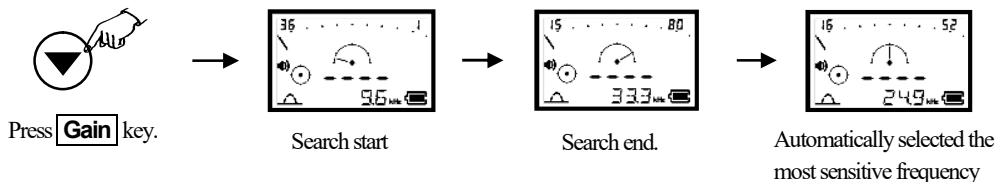

Search frequencies in several bands

Press **Gain** during search, Search stops. Resume search, the search starts from the halted frequency.

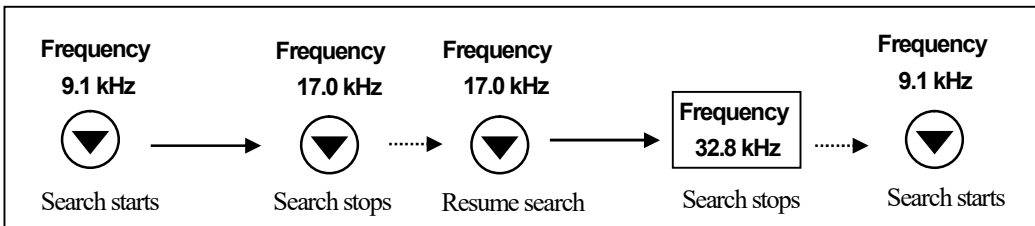

Above mentioned example shows the first search detects the most sensitive frequency from 9.1k to 17kHz. And then search is halted. Then, search resumes. The second search detects the most sensitivity frequency from 17k to 32.8kHz. Applying this function, several different kind of cables can be detected in several stages.

Decide the place of the starting point. Press **Gain**, locate that circumference.

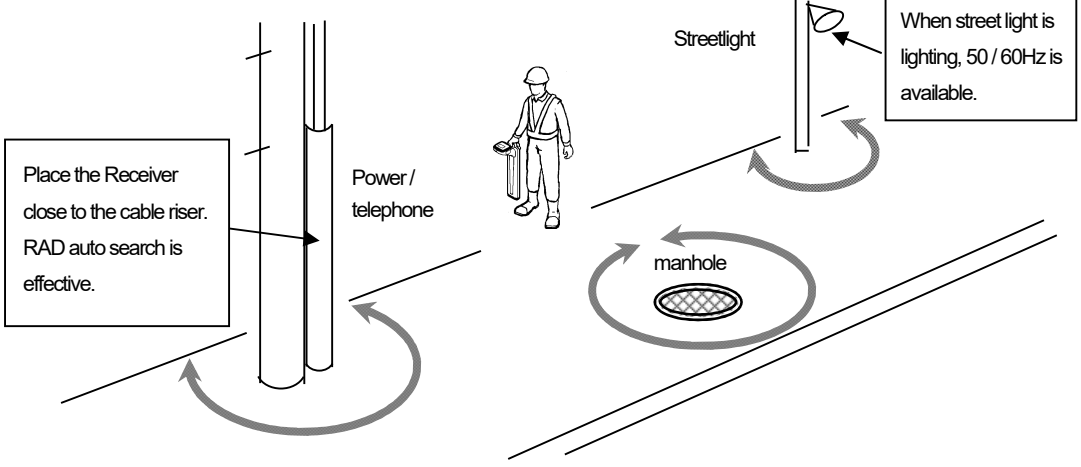

Trace a line from the starting point.

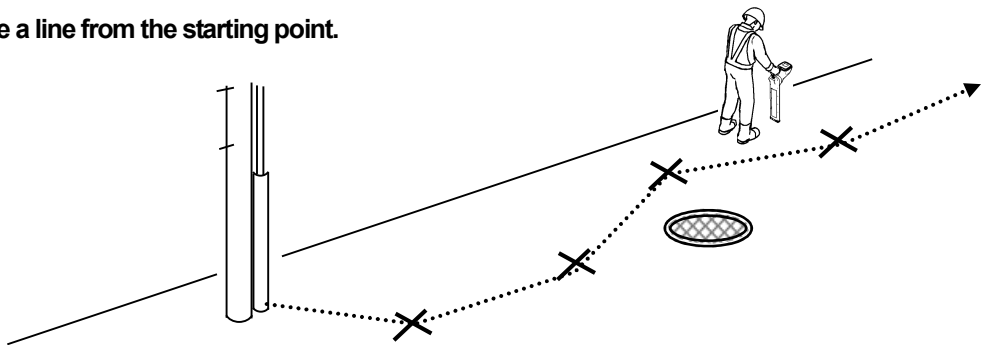

Depth measurement Press **DEPTH** key after pinpointing the location.

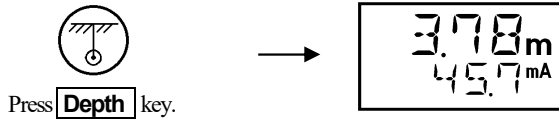

WARNING



Accuracy of the depth measurement using the passive modes is unreliable. Always expose the utility lines by exposing in a non-destructive manner before excavation.

8-8. Probe for non-metallic pipe

A Probe, supplied as optional equipment, is a small waterproof transmitter emitting a signal that is traced by the Receiver.

The Probe can only be used in the non-metallic pipe.

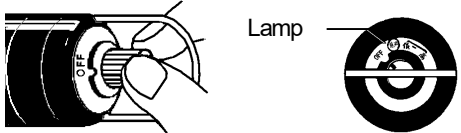
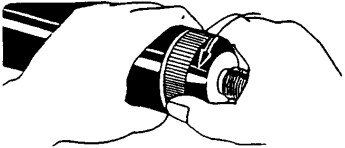
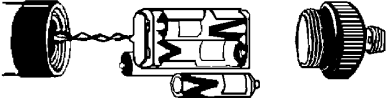
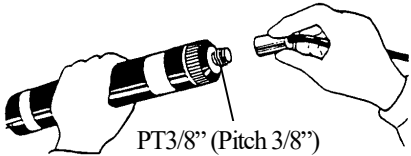
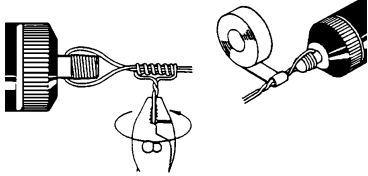
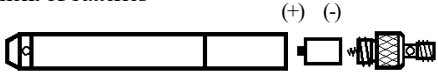
Note : The metal pipe conceals a signal so that the Receiver cannot detect the signal. Use Direct connection mode.

<p>Battery check</p> <ol style="list-style-type: none"> Set the rotary select switch to BATT. Check if the green lamp is ON. If the lamp is OFF, replace all batteries with new ones. 	 <p>Lamp</p>
<p>Replacement of batteries</p> <ol style="list-style-type: none"> Unscrew the top cover and open the battery compartment. Four 1.5V AA (LR-6, NEDA15A) batteries are placed in series. The proper polarities for the batteries are shown on the battery holder. 	 
<p>Output setting</p> <ol style="list-style-type: none"> OUTPUT LOW: 0.7 ft to 5.8 ft (0.2 m to 1.8 m) ⇒ less than 4ft / 1 m OUTPUT HIGH: 5.9 ft to 16 ft (1.8 m to 5 m) ⇒ more than 4 ft / 1 m 	
<p>Attach the Sewer probe to the rodding tool and insert the probe into the pipe.</p>  <p>PT3/8" (Pitch 3/8")</p>	<p>Attach the Sewer probe to the Pulling eye with the pulling wire and pull the probe with the wire.</p> 
<p>Mini-Probe Small probe for 1" Fiber optic duct or non-directional boring tools</p> <p>Replacement of batteries</p>  <p>(+) (-)</p> <p>*Mini-probe doesn't have battery check function. Check the transmission of the probe on the ground before locating.</p> <p>Attach the Mini-probe to the Pulling eye</p>  <p>Attach the Mini-probe to the rodding tool</p>  <p>M10(mm) thread</p>	

Tracing a non-metallic drain or plastic pipe with the Probe.

Ex. Feed the Probe into the PVC pipe and locate the blockage or collapse

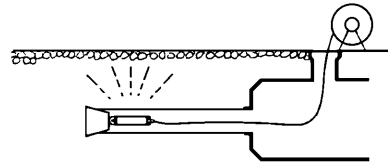

Receiver ⇒ Press **Frequency** key to set the same frequency of the probe.

Set the detection mode to Probe mode.

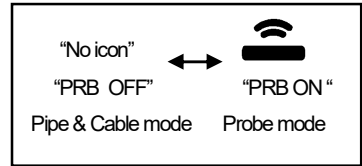
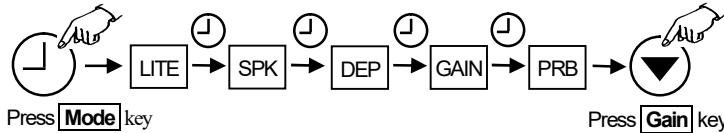

Location measurement (horizontal direction of the line)

Apply **Peak mode**. Horizontal direction can not be detected with Null mode. Use the Receiver parallel to the object line like the drawing

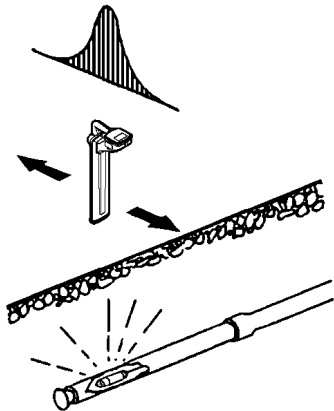

Location measurement (Same direction in the line)

Peak mode.

Three sensitivity peaks appear. The largest peak is the point directly above the Probe.

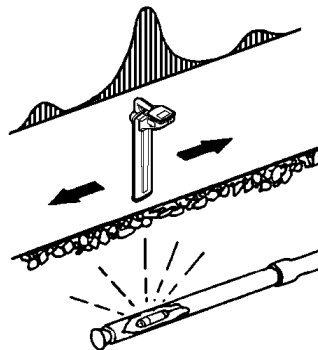

Null mode

When near the Probe, arrow indicates the location above the Probe. When away from the Probe, the receiving level flashes and the arrow indicates opposite direction.

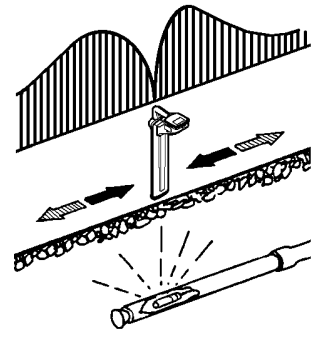

Depth measurement ⇒ Press **DEPTH** key

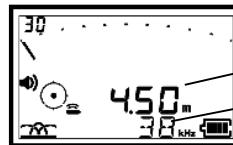

Depth
Current index is not displayed.

* For the Sewer probe :

OVER ⇒ Change the output to OUTPUT LOW.

LOW ⇒ Change the output to OUTPUT HIGH.

* For the Mini- probe :

OVER ⇒ Receiver is too close to probe.

LOW ⇒ Receiver is too far away from probe.

* If tracking a boring tool, Probe should be housed in a metal housing with slots milled in housing to allow signal to escape. Location is done as above.

9. Precautions and applications (At the locating site)

1) Locating Work Near the Guardrail (In Indirect mode)

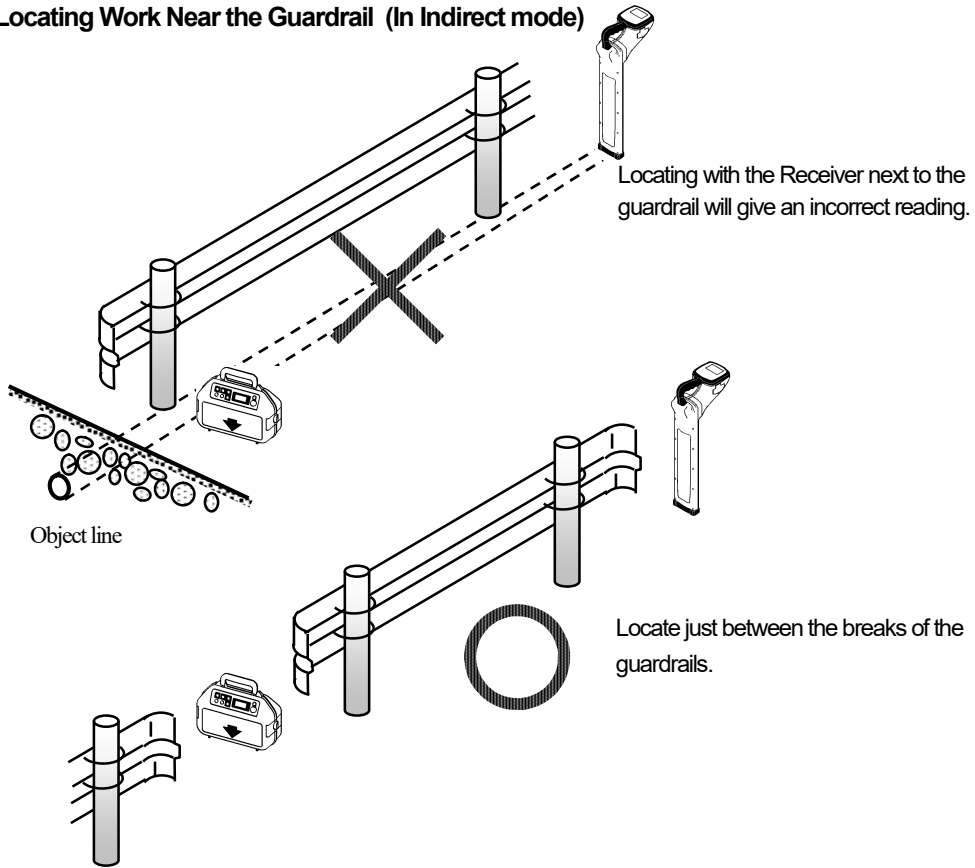

2) Metal Fences or Other Metallic Structures

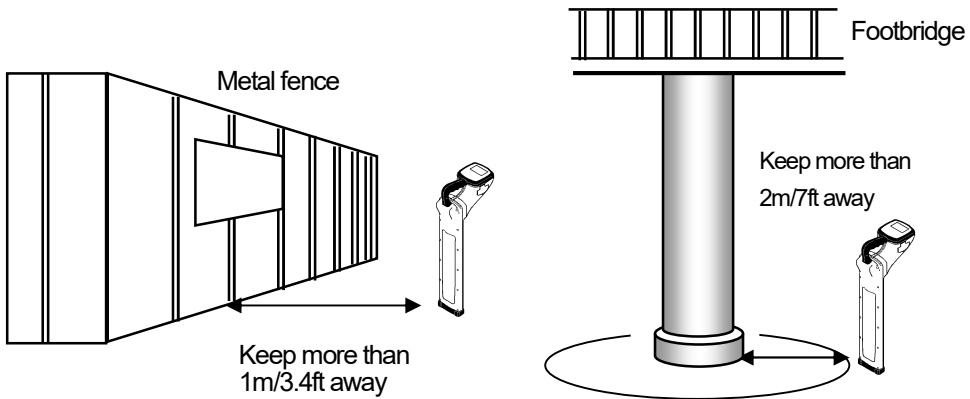

3) Street Light, Traffic-Control Sign

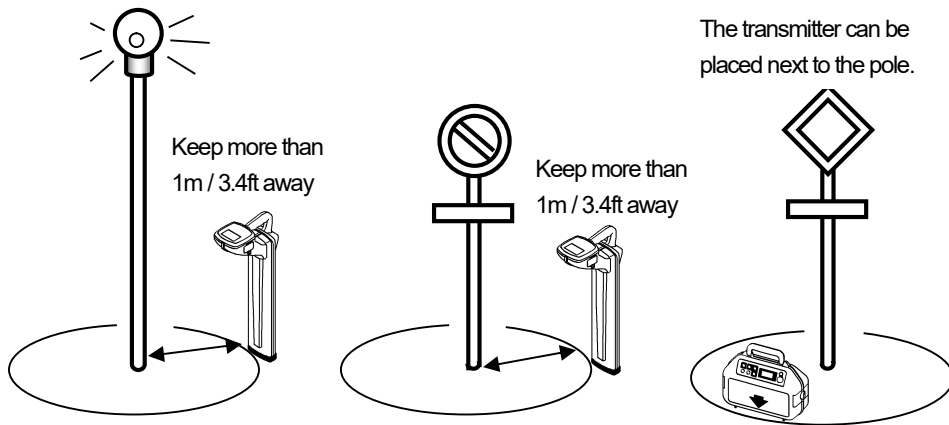

4) Power-Transmission Tower

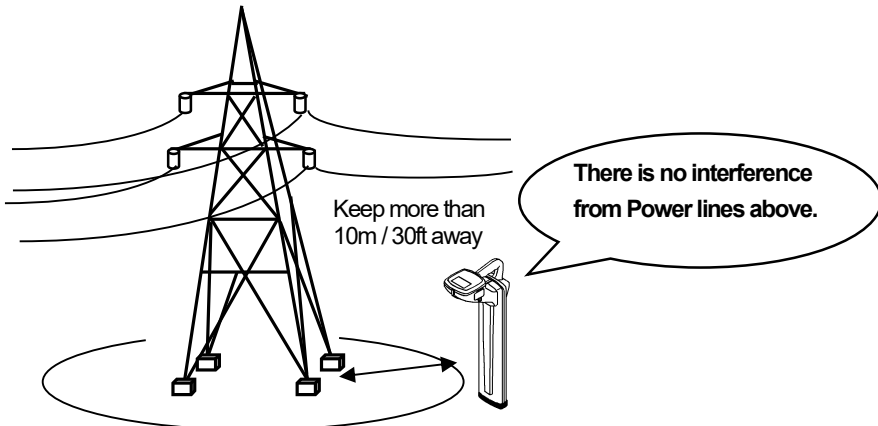

5) Telephone / Electric Power Poles

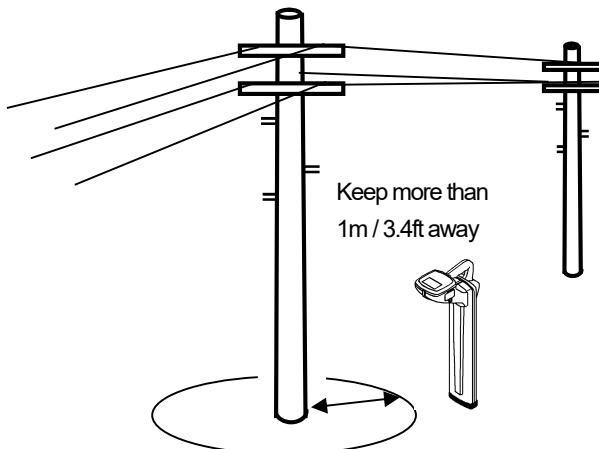

6) Heavy Traffic Flow

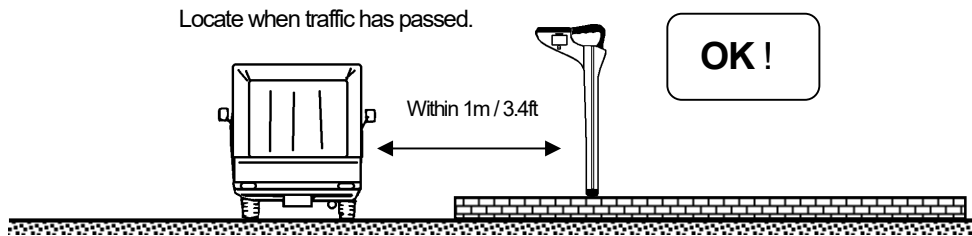
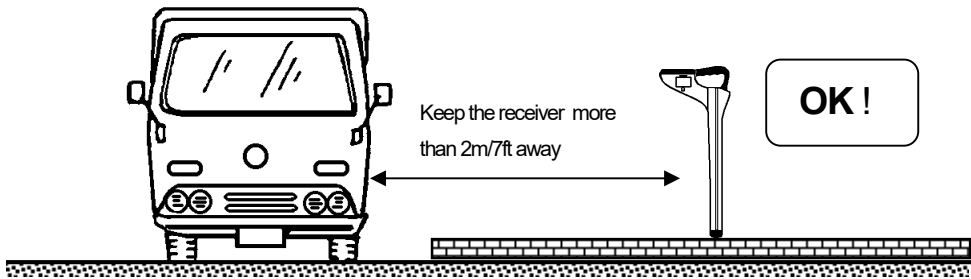

7) Railroads

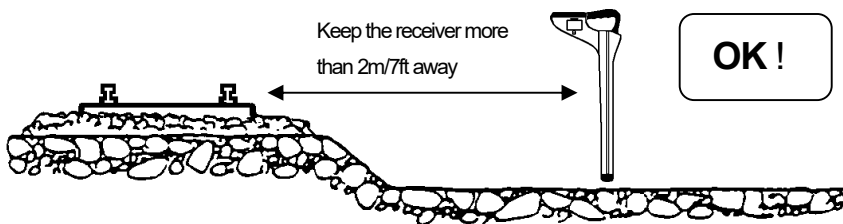
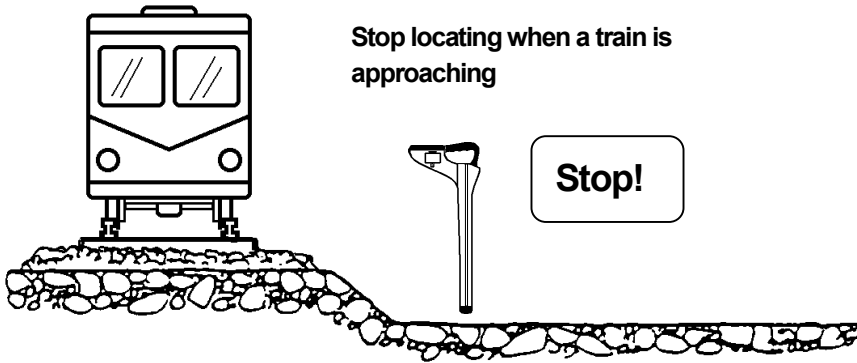

Call & Contact

 **TAKACHIHO SANGYO CO., LTD.**

Tokyo office

19-6, 5-Chome, Shiba, Minato-Ku, Tokyo 108-0014 TEL 81-3-3453-4778

Head office & Factory in Nagoya, Japan